



ANLY TIMER

H3D-M MULTI-FUNCTION ANALOGUE TIMER



CHARACTERISTICS :

- Wide operating voltage range, AC 24~240V, DC 12~240V
- 7 output modes :
On-delay
Control contact OFF-delay
Interval
Trailing edge interval
Flasher starting with ON
Flasher starting with OFF
Single shot
- 7 time range, from 1 second to 100 hour
- 17.5 mm thin body design
- UL, C-UL recognized and CE certified

SPECIFICATION :

| | |
|-----------------------------------|--|
| Operating voltage | AC(V): 24~240 DC(V): 12~240 |
| Allowable operating voltage range | 90~110% of rated operating voltage |
| Rated frequency | 50 / 60 Hz |
| Contact rating | 250VAC 8A (resistive load) |
| Reset time | MAX 0.1s |
| Power consumption | Approx. 1.9VA |
| Life | Mechanical: 5,000,000 times Electrical: 100,000 times |
| Ambient temperature | -10 ~ +50°C |
| Ambient humidity | MAX 85%RH |
| Weight | Approximatly 62g |

TYPE SELECTION :

| | |
|----------------|---|
| Type | H3D-M |
| Time range | 1s / 10s / 100s / 10m / 100m / 10h / 100h |
| Output contact | 1C |
| Output mode | 7 Mode |

CONNECTION :

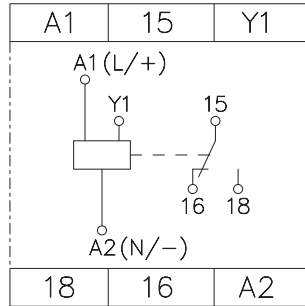

TIMING CHART :

Mode A: On-delay,

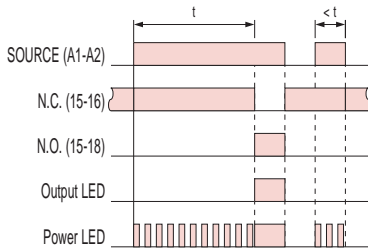

Mode B: Flasher starting with OFF,

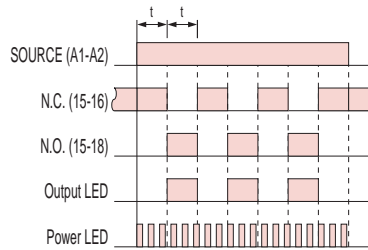

Mode B2: Flasher starting with ON,

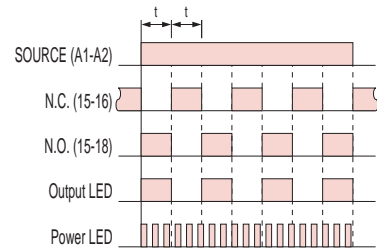

Mode D: Control contact OFF-delay,

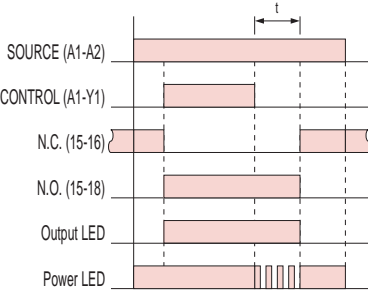

Mode D1: Trailing edge interval,

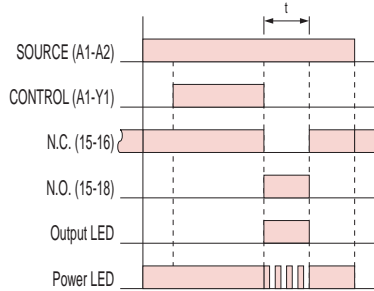

Mode E: Interval,

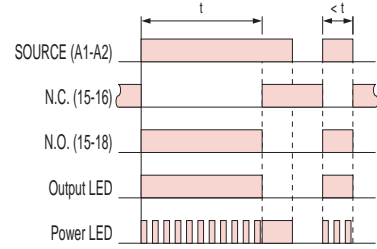

DIMENSIONS : (mm)

Mode J1: Single shot,

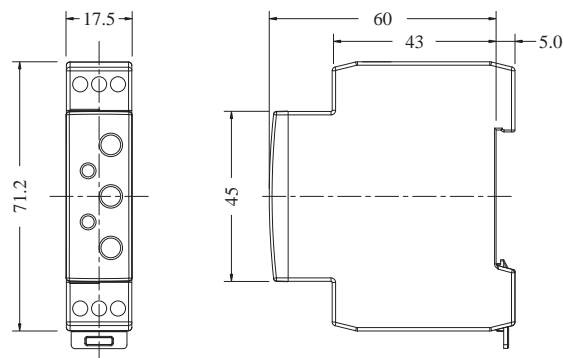
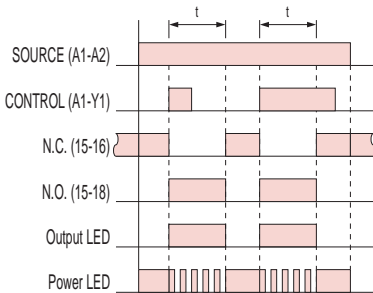

ANLY ELECTRONICS CO., LTD.

<http://www.anly.com.tw>

TAIWAN MAIN OFFICE : ANLY ELECTRONICS CO., LTD.

No.19, Lane 202, Fushou St., Xinzhuang Dist., New Taipei City 242, Taiwan
TEL: +886-2-2996-3202 FAX: +886-2-2996-2017

MALAYSIA BRANCH : JUSTY ELECTRONICS (M) SDN, BHD.

No.1, Jalan 6/89B, Kawasan Perindustrian Trisegi, Batu 3 1/2 Off Jalan Sungei Besi, 57100 Kuala Lumpur, Malaysia
TEL: +60-3-7983-5758 FAX: +60-3-7981-5052

HONG KONG BRANCH : ANLY ELECTRONICS (HK) LTD.

Flat K, 13/F, Edward Mansion, 141 Prince Edward Road W., Kowloon, Hong Kong
TEL: +852-2397-2505 FAX: +852-2397-6080

SHANGHAI BRANCH : ANLY TECHNOLOGY (WUXI) CO., LTD.

Room 13G, No.831, Xinzha Rd., Jingan District, Shanghai, China 200041
TEL: +86-21-6218-3300 FAX: +86-21-6217-5911

NO. H3DM-L-B