



ANLY CONTROLLER

APR-3,-3S / ASV-4 / ASM-170 3-PHASE SEQUENCE VOLTAGE RELAY



CHARACTERISTIC :

- Only operational with correct power source voltage and phase sequence
- Suitable for main power source and motor starter circuit to prevent damage from insufficient phase or phase reversal
- Out-of-phase detection while the motor operating*

Note: "*" indicates not applicable to APR-3

SPECIFICATION :

Operating voltage	AC(V) : 220, 240, 380, 415, 440(APR-3) AC(V) : 208~440 (APR-3S, ASV-4, ASM-170)
Allowable operating voltage range	85~110% of rated operating voltage
Rated frequency	50 / 60 Hz
Contact rating	250VAC 10A resistive load(APR-3) 250VAC 5A resistive load(others)
Reset time	APR-3: none, ASV-4: 300~600msec APR-3S, ASM-170: MAX 200msec
Power consumption	Approx. 2VA
Life	Mechanical: 5,000,000 times Electrical: 100,000 times
Ambient temperature	-10 ~ +50°C (without condensation & freezing)
Ambient humidity	MAX 85% RH (without condensation)
Altitude	MAX 2000m
Weight	APR-3, ASV-4 Approx. 85g APR-3S Approx. 70g ASM-170 Approx. 100g

TYPE SELECTION :

Type	APR-3	APR-3S	ASV-4	ASM-170
Source type	3-Phase 3-Wire	3-Phase 3-Wire	3-Phase 4-Wire	3-Phase 3-Wire
Number of pins	8P	8P	8P	11P
Indicator operating	none	Red LED(ON) Green LED(PWR)	Red LED(TRIP) Green LED(UP)	Red LED(ON) Green LED(POWER)

CONNECTION :

APR-3

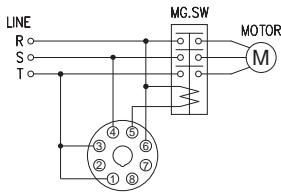

APR-3S

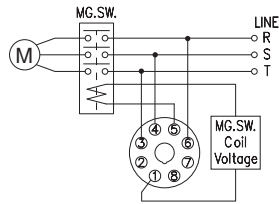

ASV-4

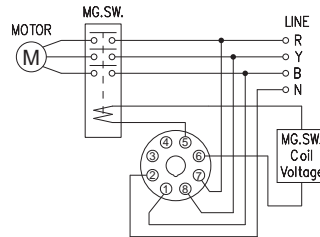

ASM-170

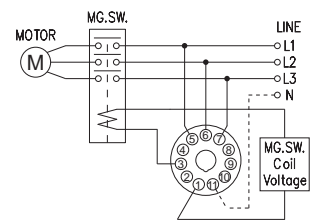

TIMING CHART :

APR-3,3S

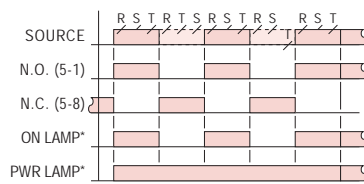

*For APR-3S only

ASV-4

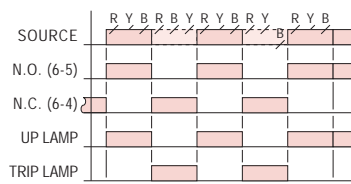

ASM-170

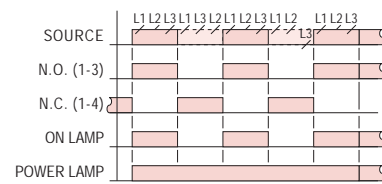

DIMENSIONS : (mm)

APR-3, APR-3S, ASV-4 N type(Surface Mounting): Using PF085A Socket & FH-3

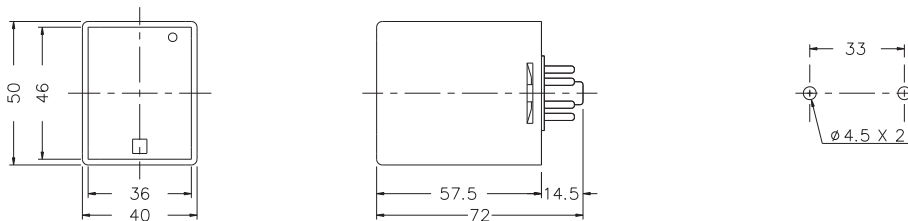

ASM-170 N type(Surface Mounting): Using PF-113BE Socket & A35

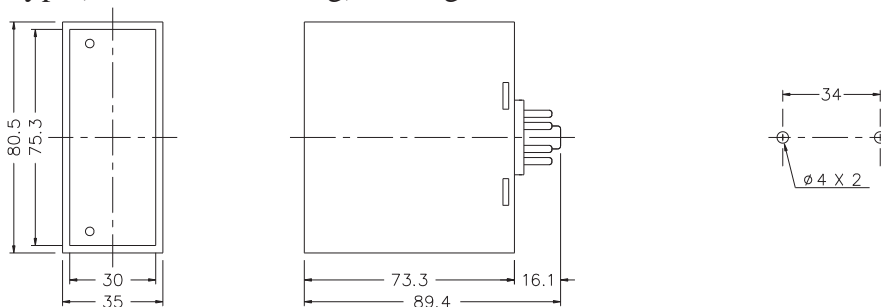

Tolerance:±0.1

ANLY ELECTRONICS CO., LTD.

<http://www.anly.com.tw>

TAIWAN MAIN OFFICE : ANLY ELECTRONICS CO., LTD.

No.19, Lane 202, Fushou St., Xinzhuang Dist., New Taipei City 242, Taiwan
TEL: +886-2-2996-3202 FAX: +886-2-2996-2017

HONG KONG BRANCH : ANLY ELECTRONICS (HK) LTD.

Flat K, 13/F, Edward Mansion, 141 Prince Edward Road W., Kowloon, Hong Kong
TEL: +852-2397-2505 FAX: +852-2397-6080

SHANGHAI BRANCH : ANLY TECHNOLOGY (WUXI) CO., LTD.

Room 13G, No.831, Xinzha Rd., Jingan District, Shanghai, China 200041
TEL: +86-21-6218-3300 FAX: +86-21-6217-5911

MALAYSIA BRANCH : JUSTY ELECTRONICS (M) SDN. BHD.

No.1, Jalan 6/89B, Kawasan Perindustrian Trisegi, Batu 3 1/2 Off Jalan Sungei Besi, 57100 Kuala Lumpur, Malaysia
TEL: +60-3-7983-5758 FAX: +60-3-7981-5052

INDONESIA BRANCH : PT. ANLY ELECTRONICS INDONESIA

Jl. Pangeran Jayakarta 117/B9, Jakarta Pusat, 10730 Indonesia
TEL: +62-21-624-8436 FAX: +62-21-626-1228