



ANLY CONTROLLER

EP2-3 CURRENT RELAY



CHARACTERISTIC :

- Current Range:0.5-7A (or otherwise specified)
- Sampling rate:100mS
- Output Mode :
 - Power-on Delay 0~30S
 - Trip Delay 0~30S
 - Inverse Time 1-32 Level
- Over current reset at 95% of set value
- Under current reset at 105% of set value
- Manual reset and auto reset type available

SPECIFICATION :

Operating voltage	AC/DC(V): 100 - 240
Allowable operating voltage range	85 ~ 110% of rated operating voltage
Rated frequency	50 / 60 Hz
Detecting method	Detect 3-phase supply voltage
Reset time	MAX 0.1sec
Contact rating	250VAC 5A (resistive load)
Power consumption	Approx. 1.1VA
Life	Mechanical: 5,000,000 times Electrical: 100,000 times
Ambient temperature	-10 ~ +50°C (without condensation & freezing)
Ambient humidity	MAX 85%RH (without condensation)
Altitude	MAX 2000m
Weight	Approx. 80g

TYPE SELECTION :

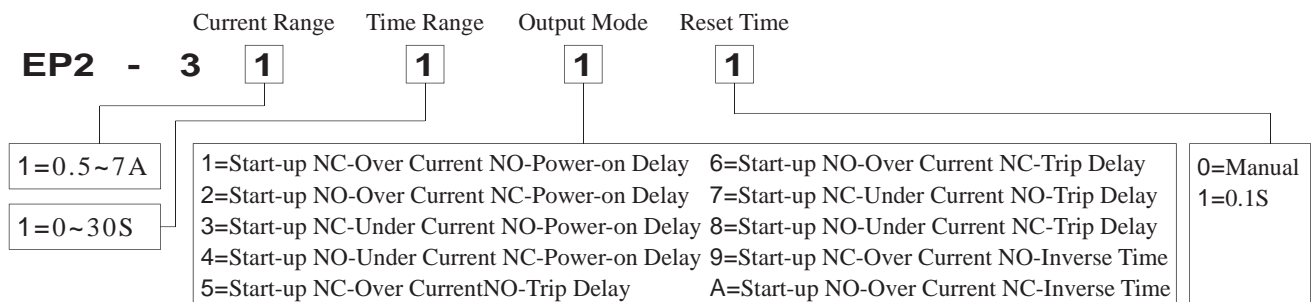

TIMING CHART :

1. Start-up NC-Over Current NO-Power-on Delay

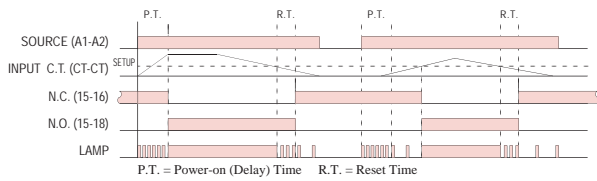

2. Start-up NO-Over Current NC-Power-on Delay

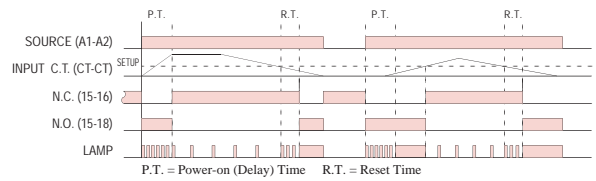

3. Start-up NC-Under Current NO-Power-on Delay

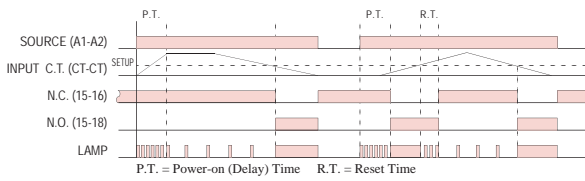

4. Start-up NO-Under Current NC-Power-on Delay

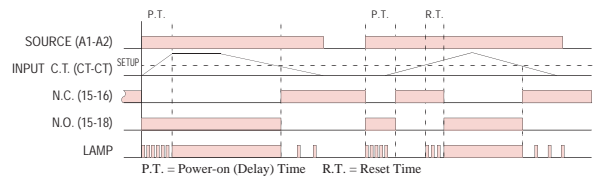

5. Start-up NC-Over Current NO-Trip Delay

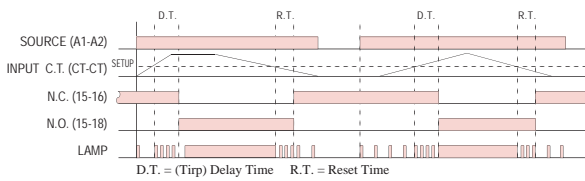

6. Start-up NO-Over Current NC-Trip Delay

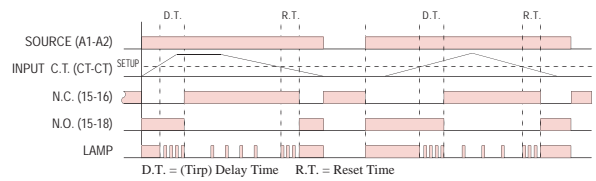

7. Start-up NC-Under Current NO-Trip Delay

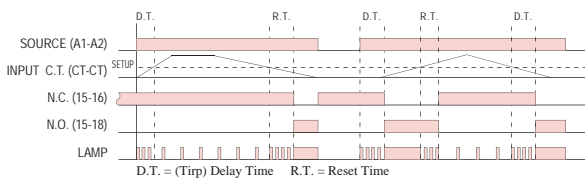

8. Start-up NO-Under Current NC-Trip Delay

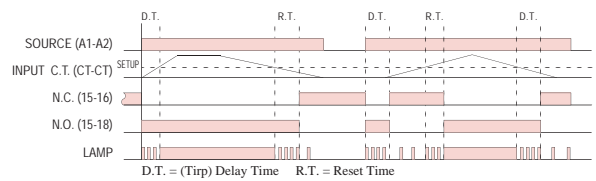

9. Start-up NC-Over Current NO-Inverse Time

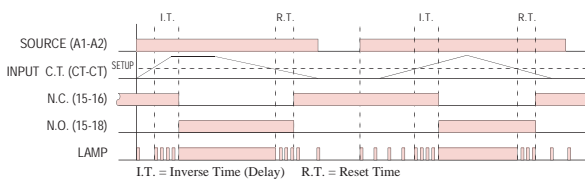

A. Start-up NO-Over Current NC-Inverse Time

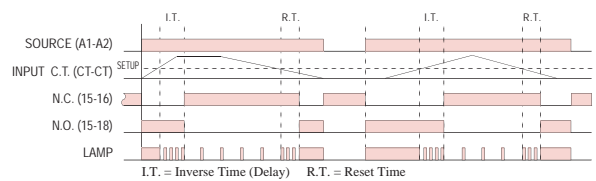

CONNECTION :

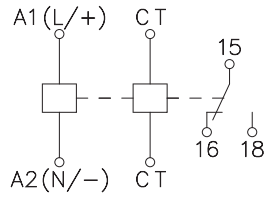

CURVE :

Inverse Time
Current Curve

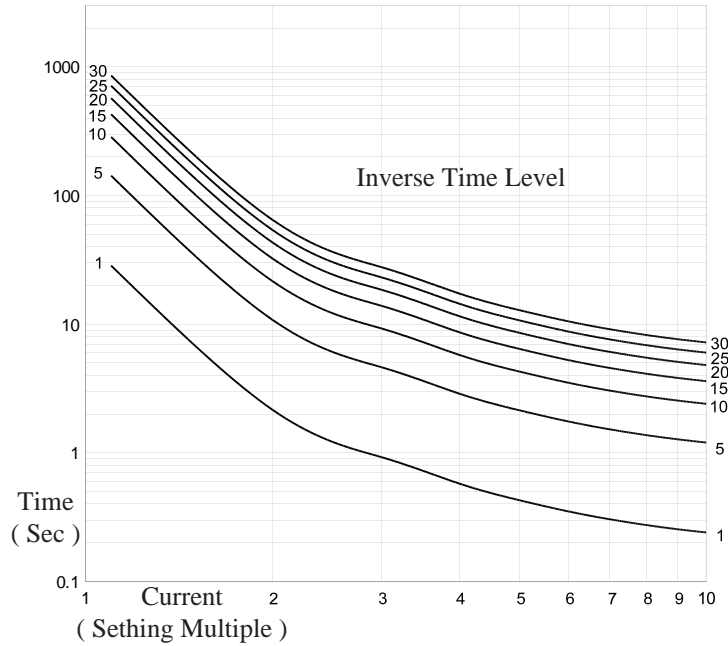

DIMENSIONS : (mm)

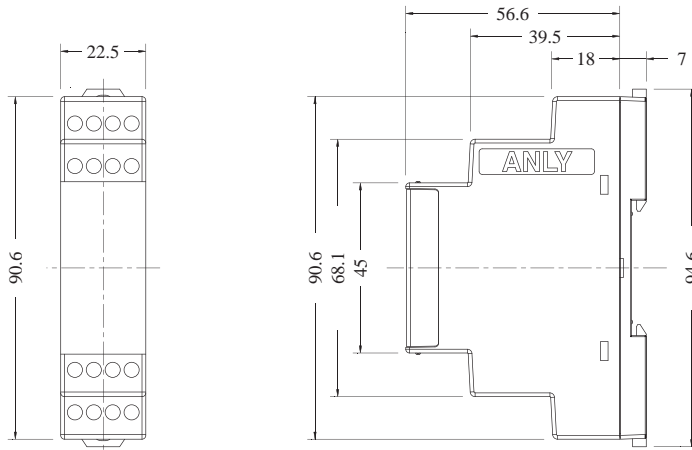

Tolerance:±0.1

ANLY ELECTRONICS CO., LTD.

<http://www.anly.com.tw>

TAIWAN MAIN OFFICE : ANLY ELECTRONICS CO., LTD.

No.19, Lane 202, Fushou St., Xinzhuang Dist., New Taipei City 242, Taiwan
TEL: +886-2-2996-3202 FAX: +886-2-2996-2017

HONG KONG BRANCH : ANLY ELECTRONICS (HK) LTD.

Flat K, 13/F, Edward Mansion, 141 Prince Edward Road W., Kowloon, Hong Kong
TEL: +852-2397-2505 FAX: +852-2397-6080

SHANGHAI BRANCH : ANLY TECHNOLOGY (WUXI) CO., LTD.

Room 13G, No.831, Xinzha Rd., Jingan District, Shanghai, China 200041
TEL: +86-21-6218-3300 FAX: +86-21-6217-5911

MALAYSIA BRANCH : JUSTY ELECTRONICS (M) SDN. BHD.

No.1, Jalan 6/89B, Kawasan Perindustrian Trisegi, Batu 3 1/2 Off Jalan Sungei Besi, 57100 Kuala Lumpur, Malaysia
TEL: +60-3-7983-5758 FAX: +60-3-7981-5052

INDONESIA BRANCH : PT. ANLY ELECTRONICS INDONESIA

Jl. Pangeran Jayakarta 117/B9, Jakarta Pusat, 10730 Indonesia
TEL: +62-21-624-8436 FAX: +62-21-626-1228