



ANLY CONTROLLER

EP4-1 MULTI FUNCTION DIGITAL VOLTAGE RELAY



CHARACTERISTIC :

- Digital voltage indicator and fault detector
- Over voltage detection with 0.1sec~120sec tripping delay
- Under voltage detection with 0.1sec~10sec tripping delay
- Phase-loss detection with 2sec fixed tripping delay
- Phase sequence detection with 0.5sec fixed tripping delay
- 3-phase voltage balance($\pm 5\%$) detection with 3sec fixed tripping delay
- Phase-loss detection with active motor
- Manual / Auto Reset selectable - 1sec or 5sec auto reset tripping delay

SPECIFICATION :

| | |
|-----------------------------------|--|
| Operating voltage | AC/DC(V): 100 - 240 |
| Allowable operating voltage range | 85 ~ 110% of rated operating voltage |
| Rated frequency | 50 / 60 Hz |
| Detecting method | Detect 3-phase supply voltage |
| Reset time | 1S / 5S |
| Contact rating | 250VAC 5A (resistive load) |
| Power consumption | Approx. 3.3VA |
| Life | Mechanical: 5,000,000 times Electrical: 100,000 times |
| Ambient temperature | -10 ~ +50°C (without condensation & freezing) |
| Ambient humidity | MAX 85%RH (without condensation) |
| Altitude | MAX 2000m |
| Weight | Approx. 130g |

TYPE SELECTION :

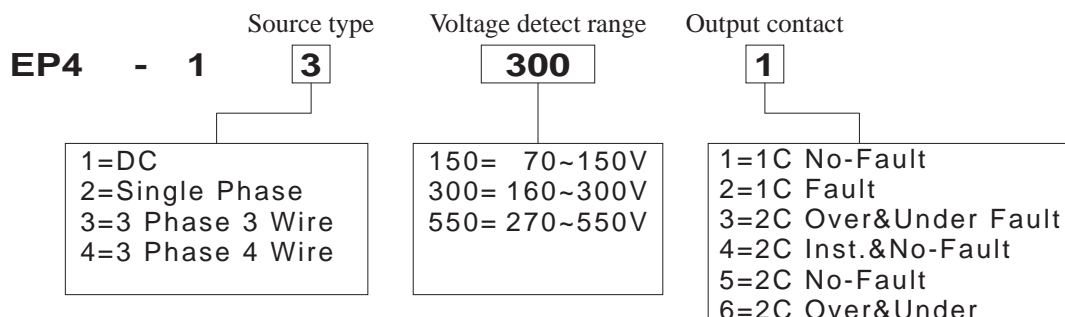

Note: Some restrictions apply, please see Table 1.

| Voltage type | | DC Type | Single Phase | 3 Phase 3 Wire | 3 Phase 4 Wire |
|----------------------|----------|------------|--------------|----------------|----------------|
| | | | EP4-11---- | EP4-12---- | EP4-13---- |
| Voltage detect range | 70~150V | EP4-11150- | EP4-12150- | EP4-13150- | - |
| | 160~300V | EP4-11300- | EP4-12300- | EP4-13300- | EP4-14300- |
| | 270~550V | - | EP4-12550- | EP4-13550- | EP4-14550- |

| Output contact | 1C No-Fault | 1C Fault | 2C Over&Under Fault |
|----------------|-------------------|-------------|---------------------|
| | EP4-1----1 | EP4-1----2 | EP4-1----3 |
| | 2C Inst.&No-Fault | 2C No-Fault | 2C Over&Under |
| | EP4-1----4 | EP4-1----5 | EP4-1----6 |

TIMING CHART :

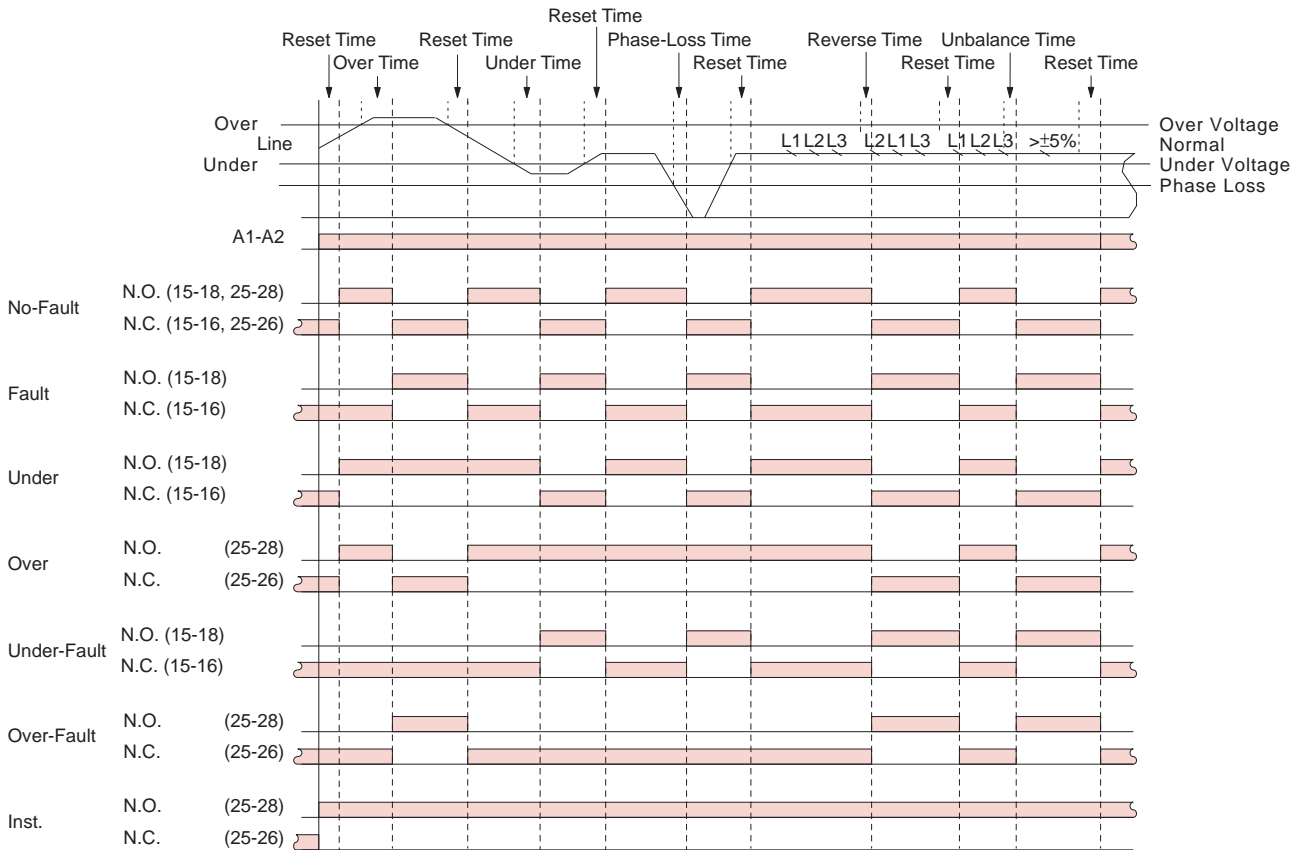

CONNECTION :

DC Type

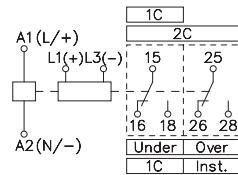

Single Phase

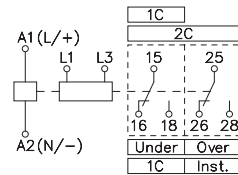

3 Phase 3 Wire

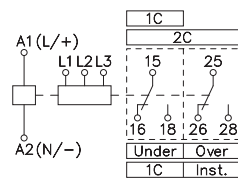

3 Phase 4 Wire

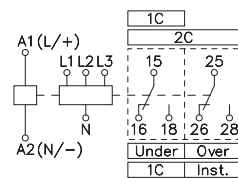

DIMENSIONS : (mm)

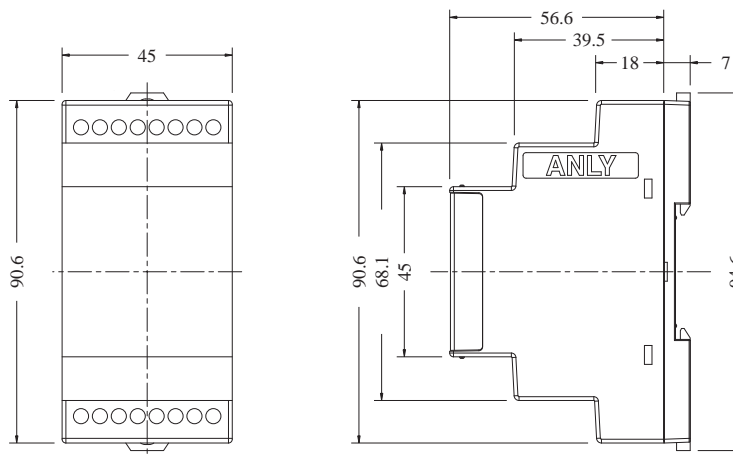

ANLY ELECTRONICS CO., LTD.

<http://www.anly.com.tw>

TAIWAN MAIN OFFICE : ANLY ELECTRONICS CO., LTD.

No.19, Lane 202, Fushou St., Xinzhuang Dist., New Taipei City 242, Taiwan
 TEL: +886-2-2996-3202 FAX: +886-2-2996-2017

MALAYSIA BRANCH : JUSTY ELECTRONICS (M) SDN, BHD.

No.1, Jalan 6/89B, Kawasan Perindustrian Trisegi, Batu 3 1/2 Off Jalan Sungei Besi, 57100 Kuala Lumpur, Malaysia
 TEL: +60-3-7983-5758 FAX: +60-3-7981-5052

HONG KONG BRANCH : ANLY ELECTRONICS (HK) LTD.

Flat K, 13/F, Edward Mansion, 141 Prince Edward Road W., Kowloon, Hong Kong
 TEL: +852-2397-2505 FAX: +852-2397-6080

SHANGHAI BRANCH : ANLY TECHNOLOGY (WUXI) CO., LTD.

Room 13G, No.831, Xinzha Rd., Jingan District, Shanghai, China 200041
 TEL: +86-21-6218-3300 FAX: +86-21-6217-5911