



ANLY CONTROLLER

EP4-1 MULTI FUNCTION DIGITAL VOLTAGE RELAY



CHARACTERISTIC :

- Digital voltage indicator and fault detector
- Over voltage detection with 0.5sec~120sec tripping delay
- Under voltage detection with 0.5sec~120sec tripping delay
- Phase-loss detection with 2sec fixed tripping delay
- Phase sequence detection with 0.5sec fixed tripping delay
- 3-phase voltage balance($\pm 5\%$) detection with 3sec fixed tripping delay
- Phase-loss detection with active motor
- Manual / Auto Reset selectable - 1sec or 5sec auto reset tripping delay

SPECIFICATION :

Operating voltage	AC/DC(V): 100 - 240
Allowable operating voltage range	85 ~ 110% of rated operating voltage
Rated frequency	50 / 60 Hz
Detecting method	Detect 3-phase supply voltage
Reset time	1S / 5S
Contact rating	250VAC 5A (resistive load)
Power consumption	Approx. 3.3VA
Life	Mechanical: 5,000,000 times Electrical: 100,000 times
Ambient temperature	-10 ~ +50°C (without condensation & freezing)
Ambient humidity	MAX 85%RH (without condensation)
Altitude	MAX 2000m
Weight	Approx. 130g

TYPE SELECTION :

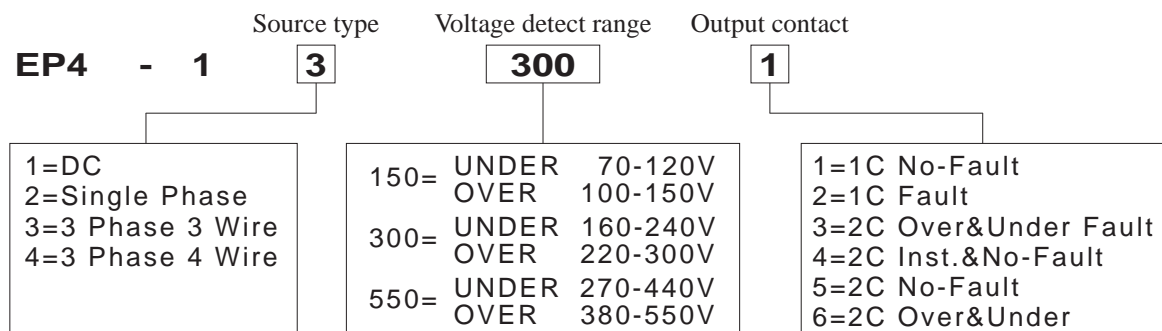

Note: Some restrictions apply, please see Table 1.

Voltage type		DC Type	Single Phase	3 Phase 3 Wire	3 Phase 4 Wire
		EP4-11----	EP4-12----	EP4-13----	EP4-14----
Voltage detect range	70-150V	EP4-11150-	EP4-12150-	EP4-13150-	-
	160-300V	EP4-11300-	EP4-12300-	EP4-13300-	EP4-14300-
	270-550V	-	EP4-12550-	EP4-13550-	EP4-14550-

Output contact	1C No-Fault	1C Fault	2C Over&Under Fault
	EP4-1----1	EP4-1----2	EP4-1----3
	2C Inst.&No-Fault	2C No-Fault	2C Over&Under
	EP4-1----4	EP4-1----5	EP4-1----6

TIMING CHART :

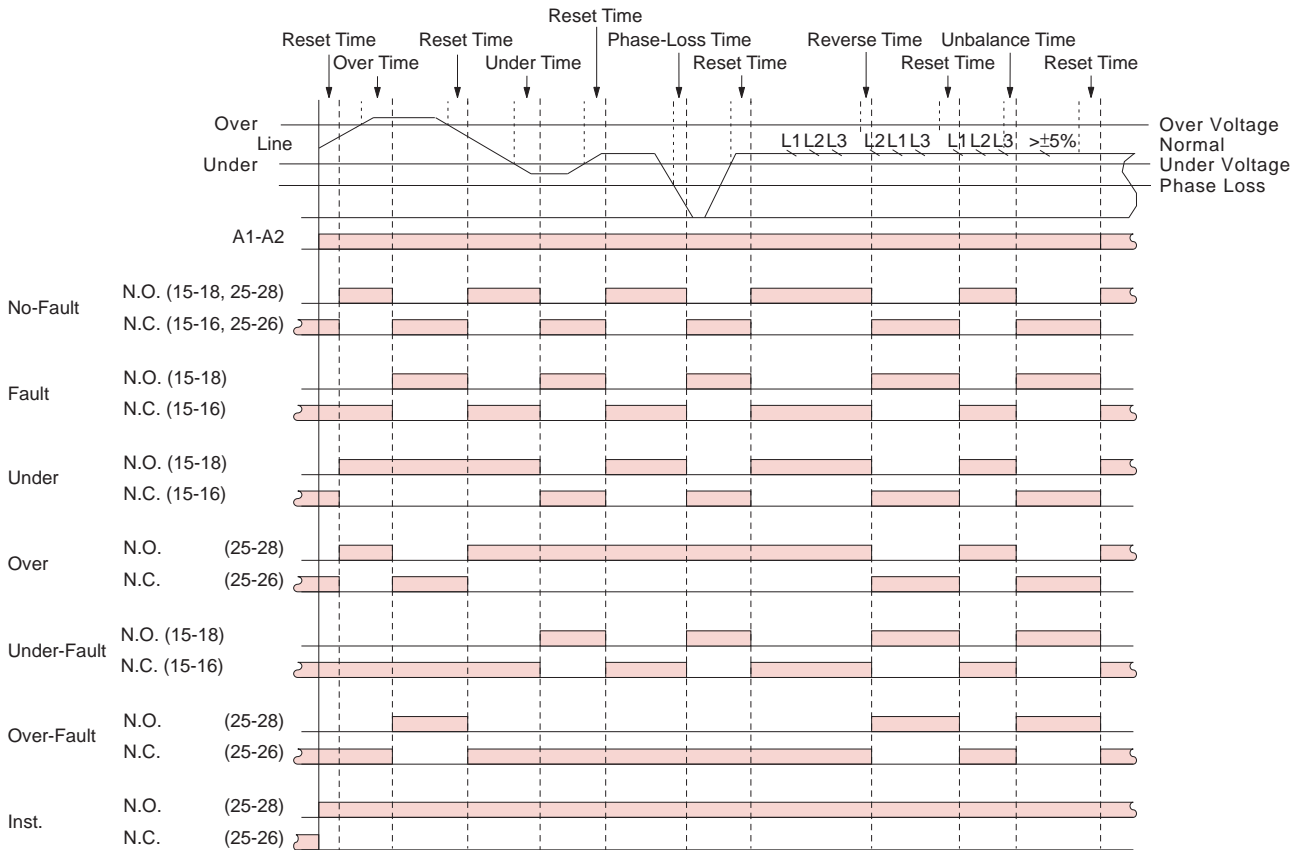

CONNECTION :

DC Type

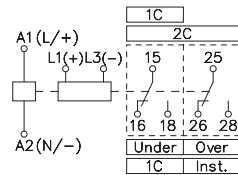

Single Phase

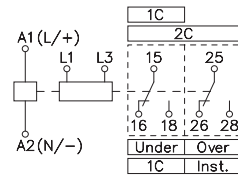

3 Phase 3 Wire

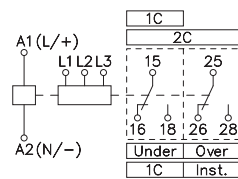

3 Phase 4 Wire

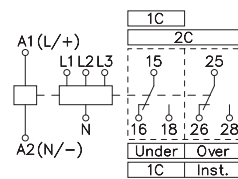

DIMENSIONS : (mm)

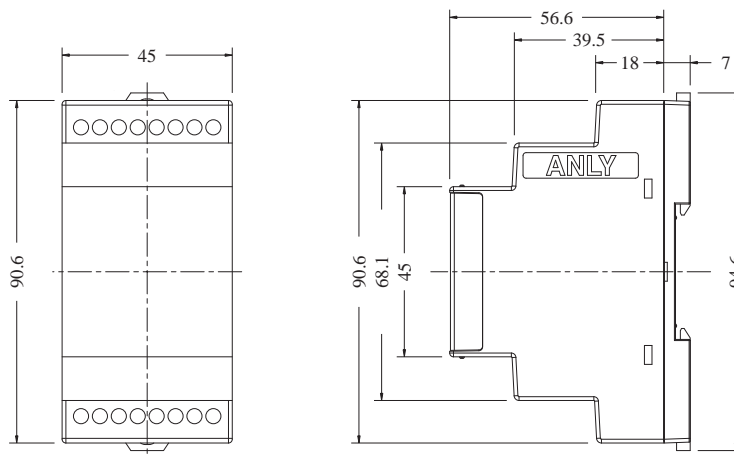

Tolerance: ± 0.1

ANLY ELECTRONICS CO., LTD.

<http://www.anly.com.tw>

TAIWAN MAIN OFFICE : ANLY ELECTRONICS CO., LTD.

No.19, Lane 202, Fushou St., Xinzhuang Dist., New Taipei City 242, Taiwan
 TEL: +886-2-2996-3202 FAX: +886-2-2996-2017

MALAYSIA BRANCH : JUSTY ELECTRONICS (M) SDN, BHD.

No.1, Jalan 6/89B, Kawasan Perindustrian Trisegi, Batu 3 1/2 Off Jalan Sungei Besi, 57100 Kuala Lumpur, Malaysia
 TEL: +60-3-7983-5758 FAX: +60-3-7981-5052

HONG KONG BRANCH : ANLY ELECTRONICS (HK) LTD.

Flat K, 13/F, Edward Mansion, 141 Prince Edward Road W., Kowloon, Hong Kong
 TEL: +852-2397-2505 FAX: +852-2397-6080

SHANGHAI BRANCH : ANLY TECHNOLOGY (WUXI) CO., LTD.

Room 13G, No.831, Xinzha Rd., Jingan District, Shanghai, China 200041
 TEL: +86-21-6218-3300 FAX: +86-21-6217-5911